



PVC WHITE SYNTHETIC DUCTING

The **PVC White** ducts are completely flexible, ducts for several applications. The ducts are suitable for flexible mounting and can be mounted to round and oval connection pieces. The **PVC White** ducts are also capable of absorbing prolonged vibrations because of its mechanical strength.

Construction:

Single layer of a strong 'White PolyVinylChlorid co-polymer' encapsulating a high tensile steel wire helix.

APPLICATIONS

- Mechanical air supply systems
- Air conditioning systems
- Exhausting/discharging at domestic equipment like clothes driers
- Ventilation cabinets

SPECIFICATIONS

Article code: P{Ø}
 Temperature range: -30 °C to 70 °C
 Operating pressure: up to +3000 Pa
 Operating air velocity: max. 30 m/s
 Bending radius: min. 0.56 x Ø
 Standard diameter range: 82 – 203 mm
 Standard length: 15 mtr

Wire spacing:
 Ø 082 mm 25mm
 Ø 102 - 203mm 36mm

Appearance: White

PRESSURE LOSS (STRAIGHT DUCT)

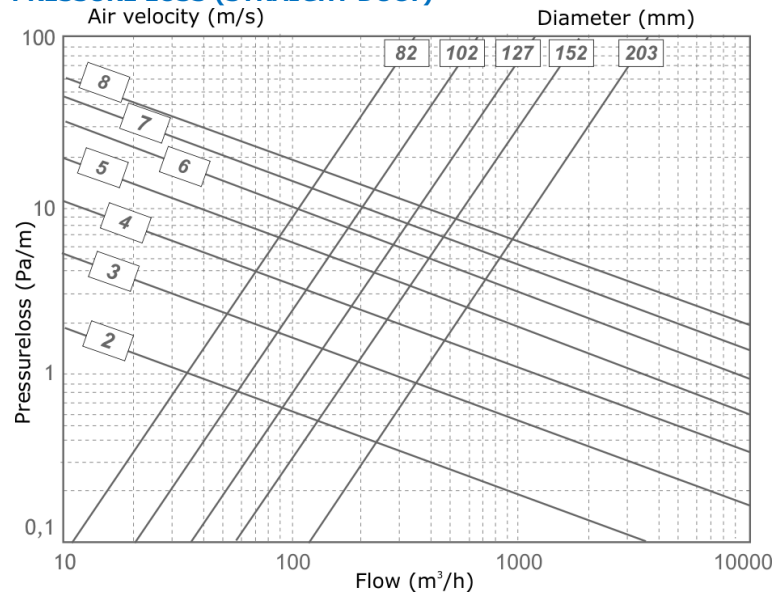

The **PVC White** fulfills all the requirements and are classified as specified within EN 13180:
Ventilation for buildings – Ductwork - Dimensions and mechanical requirements for flexible ducts.

LIABILITY:

The information contained in this brochure was current on the publication date. DEC INTERNATIONAL reserves the right to make changes in details at any time without prior notice. In order to avoid misunderstandings, any interested party is advised to contact DEC INTERNATIONAL checking for any changes in materials and/or information after this brochure was published.

PLEASE NOTICE:

The consultant is responsible for the actual installation and mounting of the product. The mentioned values with respect to temperatures are not appropriate to be used to determine the physical properties. These properties are also dependent on humidity and the temperature of the air inside and outside of the H.V.A.C. system.

TRADEMARKS:

The DEC logo and DEC International are trademarks, or registered trademarks of Dutch Environment Corporation BV in the Netherlands and/or other countries.

RESTRICTIONS:

The PVC White ducts are not suitable for discharging combustion products from open fireplaces and oil-fired boilers. Neither are the ducts suitable for transporting air with a high concentration of acid and base.